

Varenummer: 20167B252BL  
 Beskrivelse: E+G  
 Bred fod holder GN167-B25-2-BL

## Mål

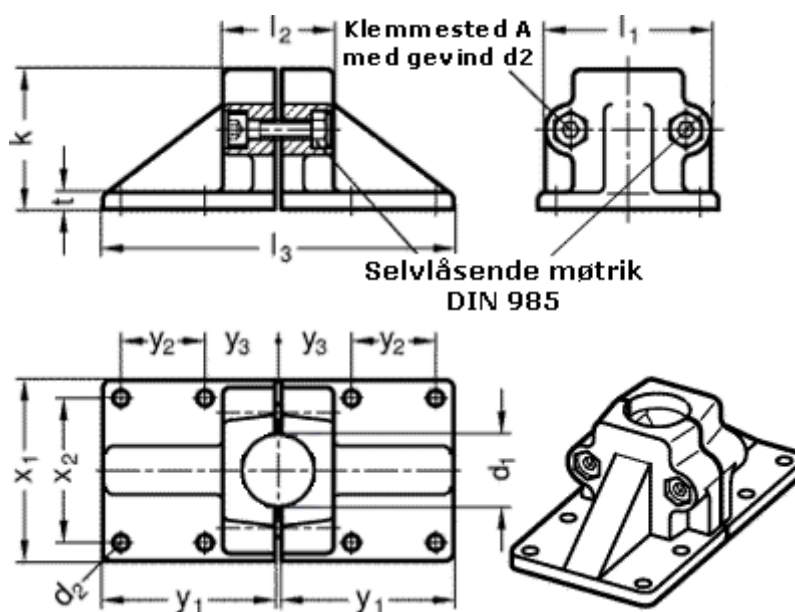

$d_1 = B25$	$x_1 = 75$
$d_2 = 7$	$x_2 = 60$
$d_3 = M 8$	$y_1 = 72$
$k = 58$	$y_2 = 35$
$l_1 = 69$	$y_3 = 30$
$l_2 = 46$	
$l_3 = 146$	
$t = 7$	